

# IZOTECH

FORMWORK & TOWERCRANES /// [www.izotech.com](http://www.izotech.com)

The logo for FM Gru features a stylized red triangle on the left, followed by the letters 'FM' in black, and 'Gru' in white inside a red rectangular box.

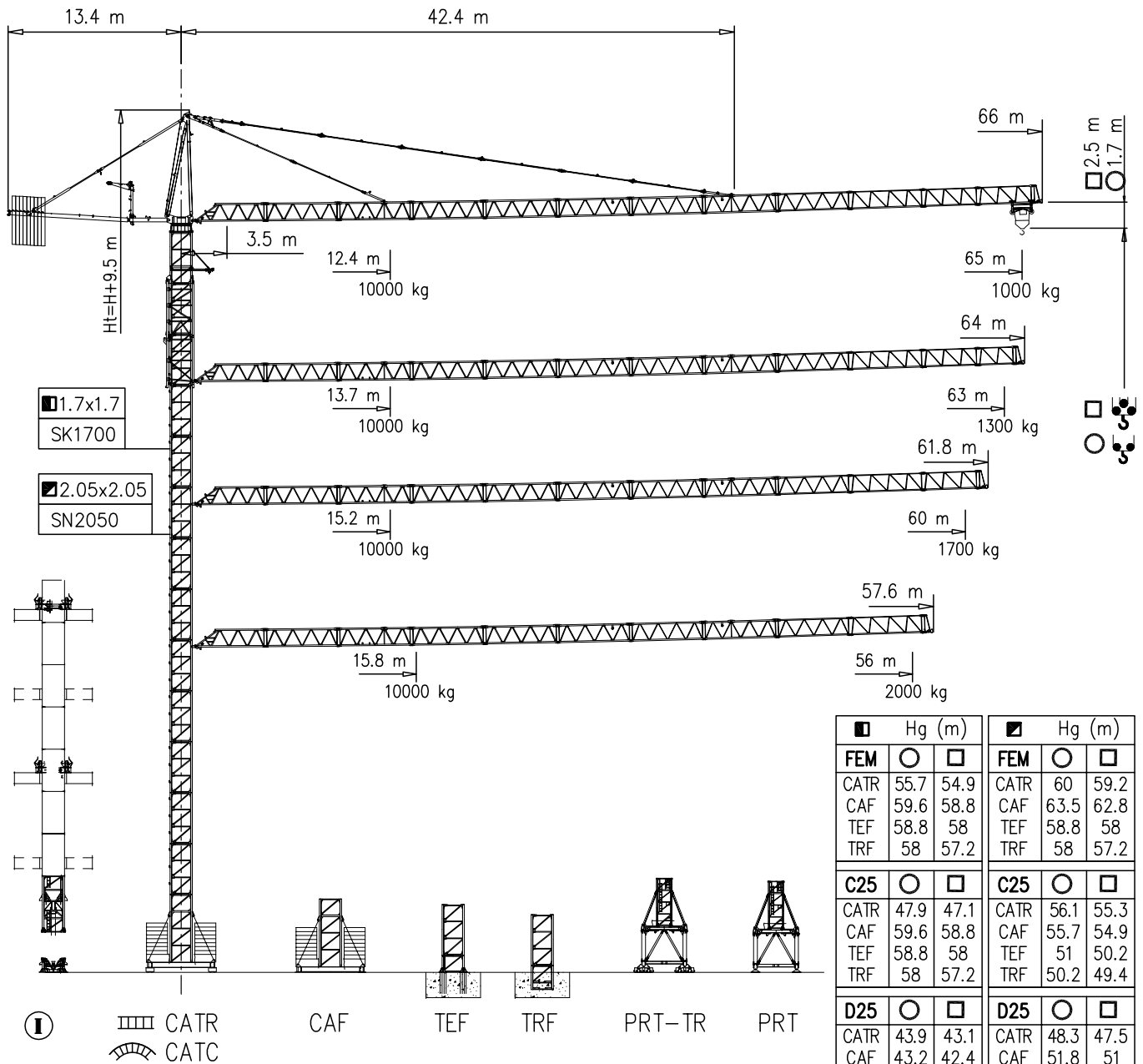

1.7x1.7  
SK1700

2.05x2.05  
SN2050

	Hg (m)		Hg (m)	
	○	□	○	□
<b>FEM</b>				
CATR	55.7	54.9	60	59.2
CAF	59.6	58.8	63.5	62.8
TEF	58.8	58	58.8	58
TRF	58	57.2	58	57.2
<b>C25</b>				
CATR	47.9	47.1	56.1	55.3
CAF	59.6	58.8	55.7	54.9
TEF	58.8	58	51	50.2
TRF	58	57.2	50.2	49.4
<b>D25</b>				
CATR	43.9	43.1	48.3	47.5
CAF	43.2	42.4	51.8	51
TEF	43.2	42.4	47.1	46.3
TRF	42.4	41.6	46.3	45.5

Power Control ASsys ACsys ULTRALIFT

**CE** FEM 1.001 - A4  
EN 14439 - C25 - D25

Torre/Reazioni – Masts/Reactions – Mat/Réactions – Maste/Eckdrücke – Mástil/Reacciones – Tramo/Reações

SK1700 FEM

○ Hg=Ht-1 m  
 □ Hg=Ht-1.8 m

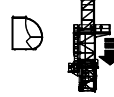
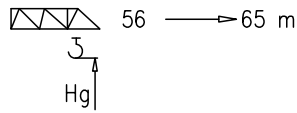

6	BCF052	2/4
5	BPF117	4/4
4	BPF039	4/4
3	ST117	2/2
2	BAF117	4/2
1	ST039	2/2

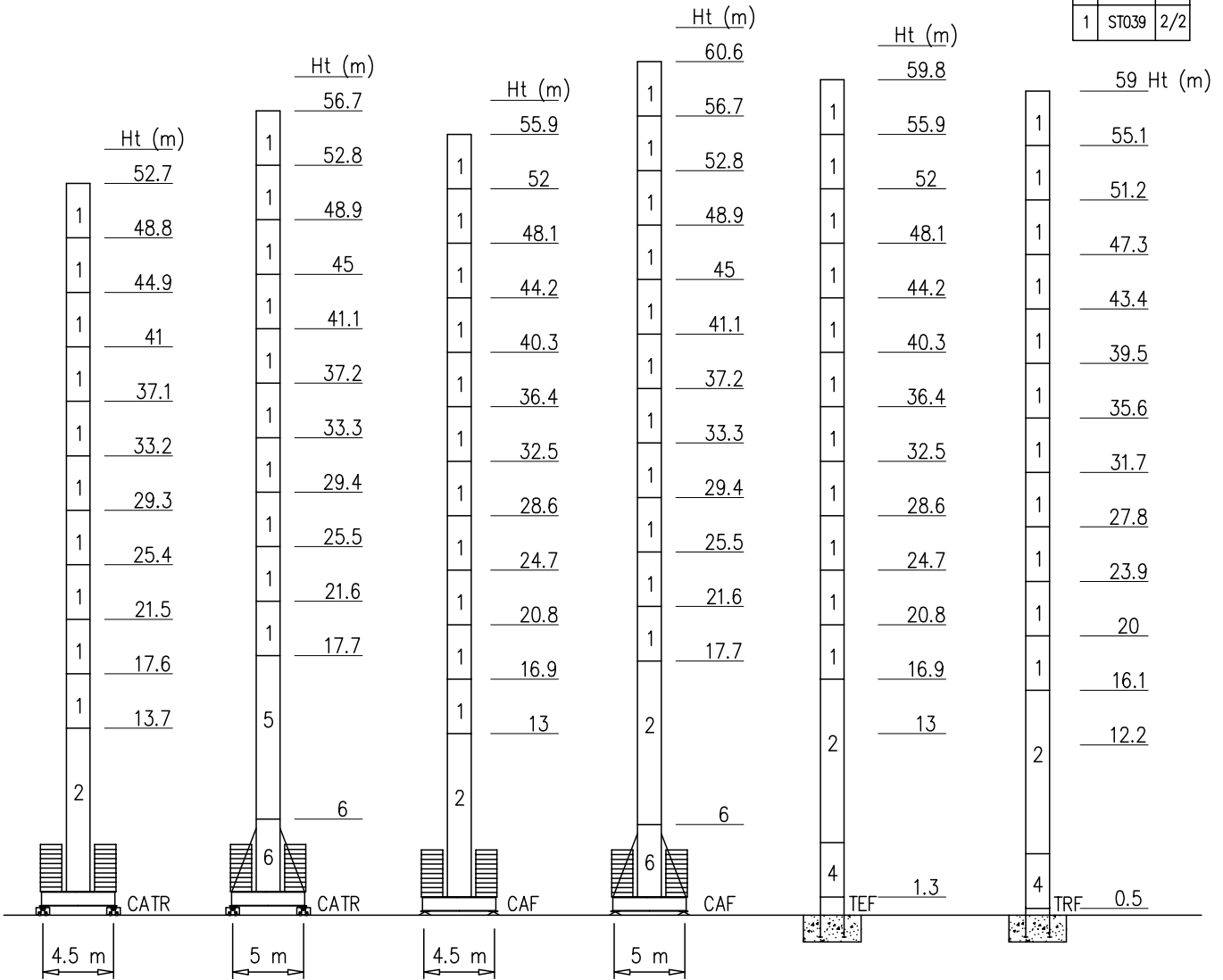

Peso zavorra – Ballast weight – Poids du lest – Ballastgewicht – Peso de lastre

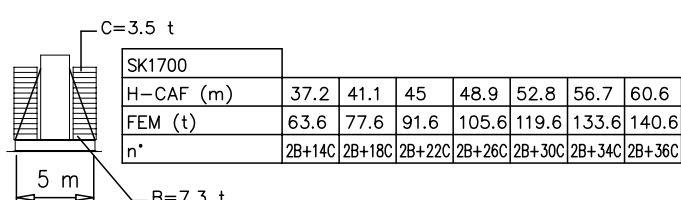
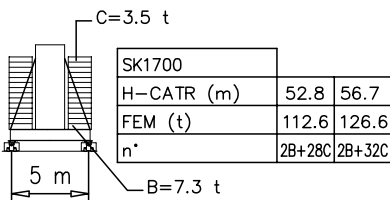
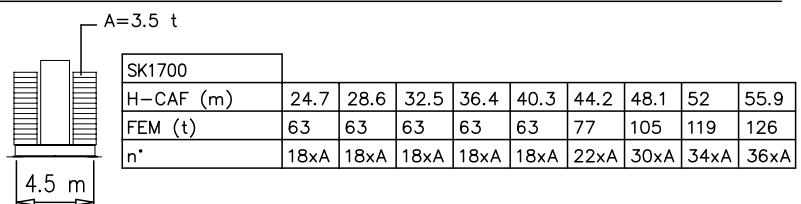
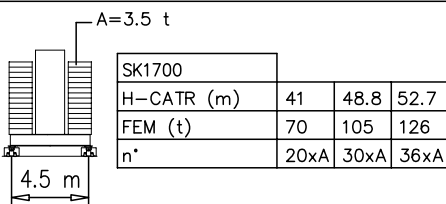

Torre/Reazioni – Masts/Reactions – Mat/Réactions – Maste/Eckdrücke – Mástil/Reacciones – Tramo/Reacções

SK1700 EN14439-C25

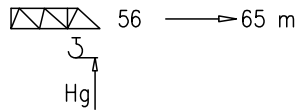

- Hg=Ht-1 m
- Hg=Ht-1.8 m

6	BCF052	2/4
5	BPF117	4/4
4	BPF039	4/4
3	ST117	2/2
2	BAF117	4/2
1	ST039	2/2

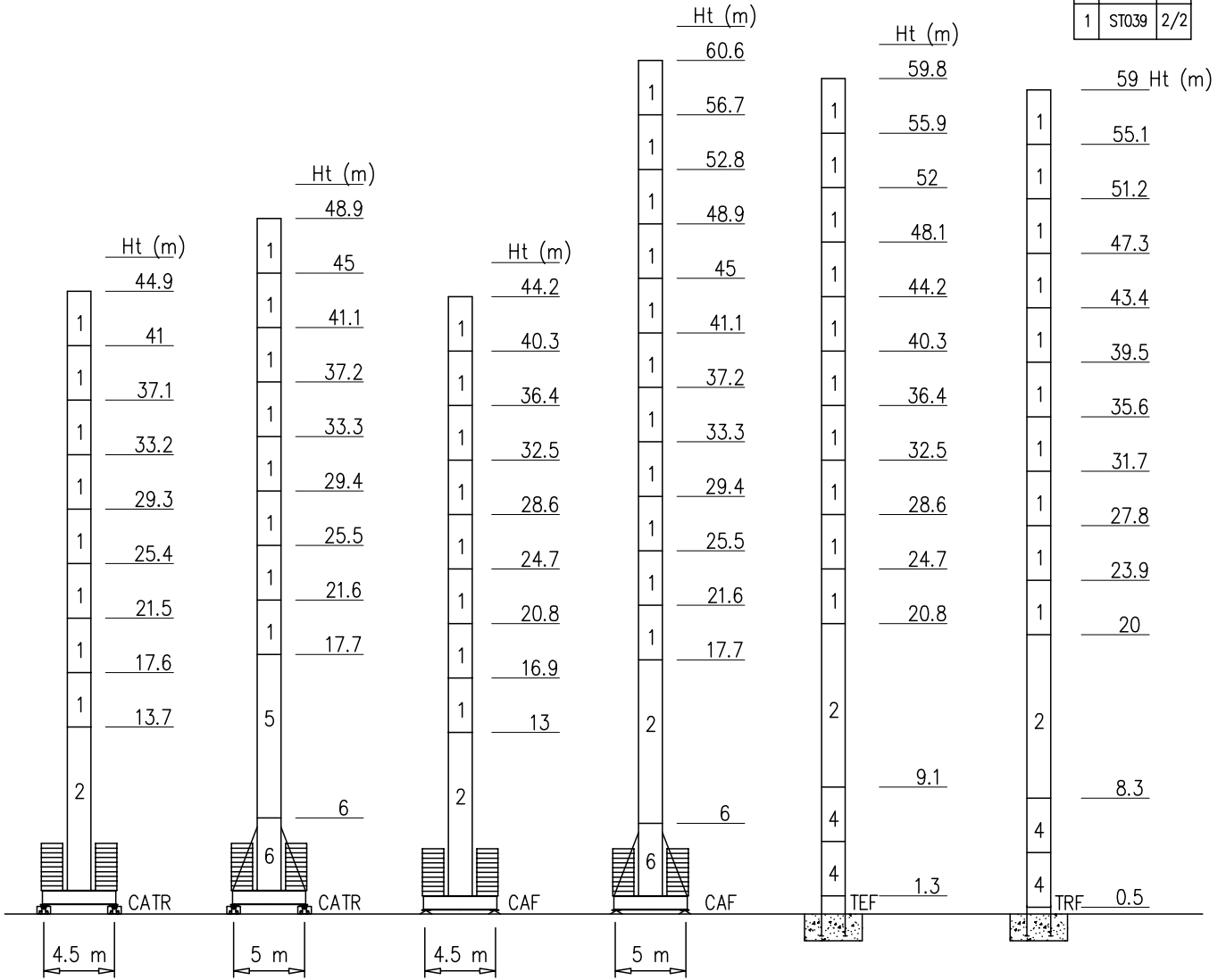

Peso zavorra – Ballast weight – Poids du lest – Ballastgewicht – Peso de lastre

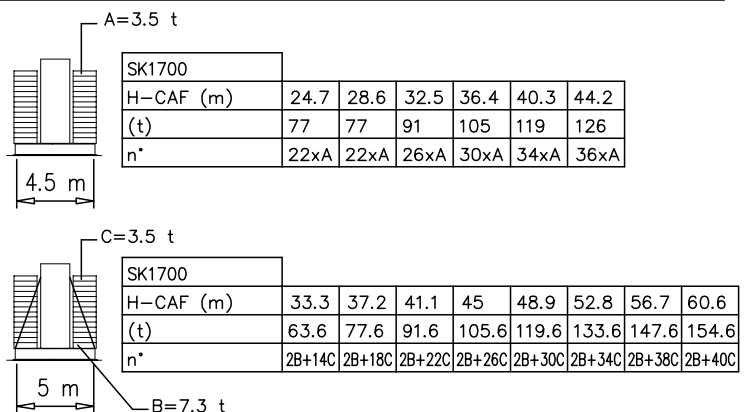
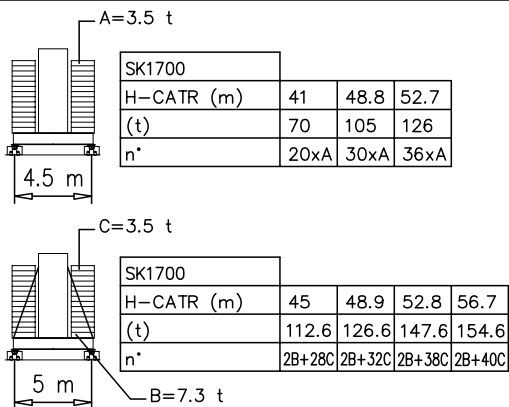

Torre/Reazioni – Masts/Reactions – Mat/Réactions – Maste/Eckdrücke – Mástil/Reacciones – Tramo/Reacções

SK1700 EN14439-D25

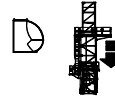
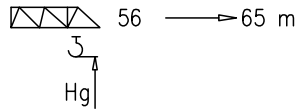

6	BCF052	2/4
5	BPF117	4/4
4	BPF039	4/4
3	ST117	2/2
2	BAF117	4/2
1	ST039	2/2

- Hg=Ht-1 m
- Hg=Ht-1.8 m

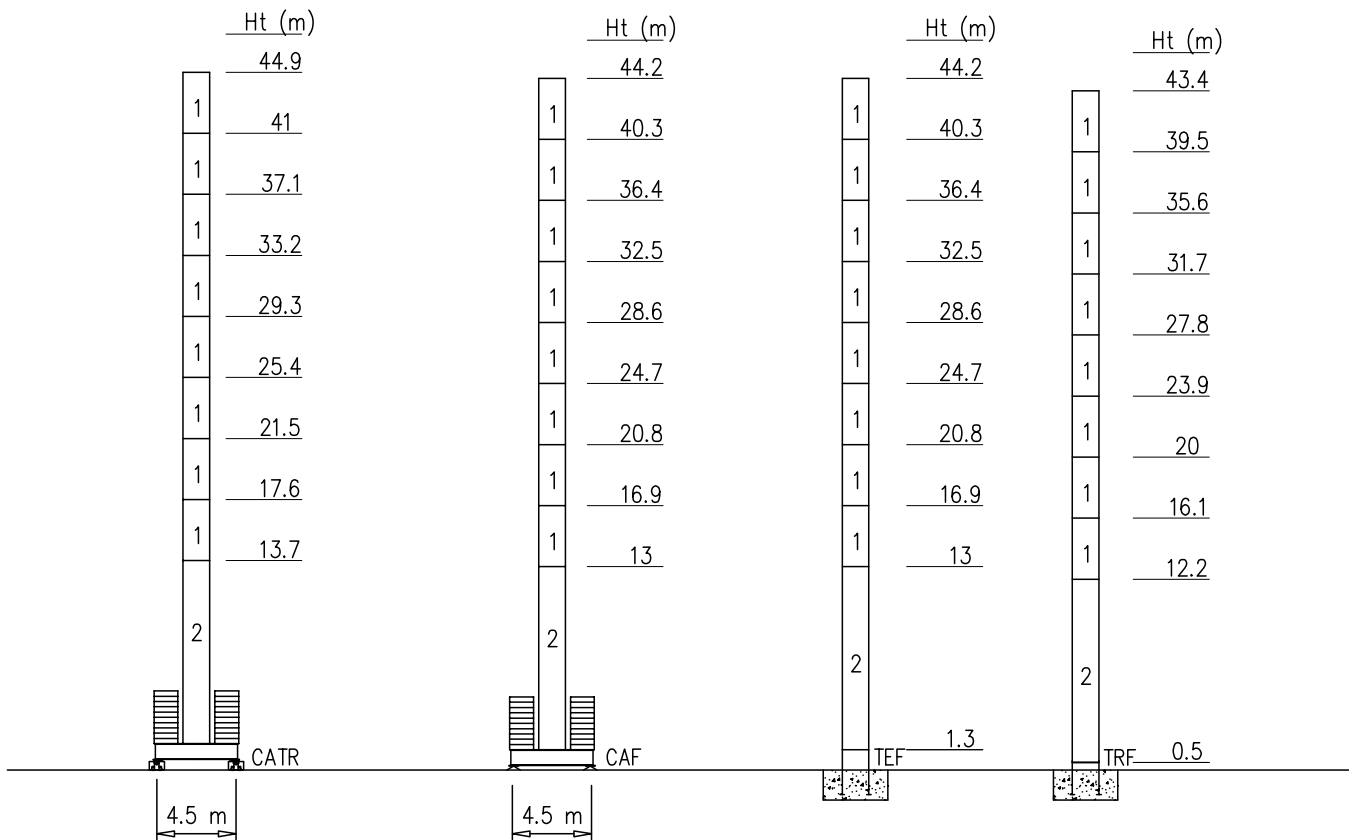

Peso zavorra – Ballast weight – Poids du lest – Ballastgewicht – Peso de lastre

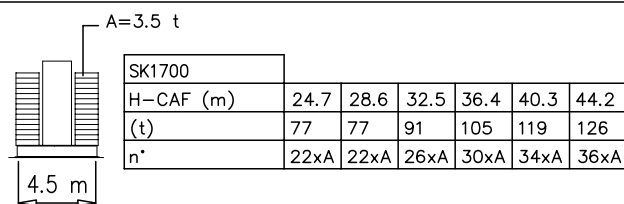
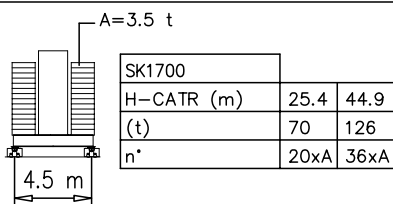

Torre/Reazioni – Masts/Reactions – Mat/Réactions – Maste/Eckdrücke – Mástil/Reacciones – Tramo/Reaçções

SN2050 FEM

○ Hg=Ht-1 m  
 □ Hg=Ht-1.8 m

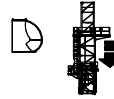
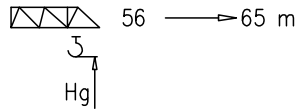

14	BCF052	2/4 M45
13	BAF052	2/4 M42
12	BPF117	4/4 M45-45
11	BNF117	4/4 M45-42
10	BOF117	4/4
9	BOF039	4/4
8	BO039	2/2
7	STR039	2/2
6	SBR117	4/2
5	SBR039	4/2
4	SB117	4/2
3	SB039	4/2
2	ST117	2/2
1	ST039	2/2

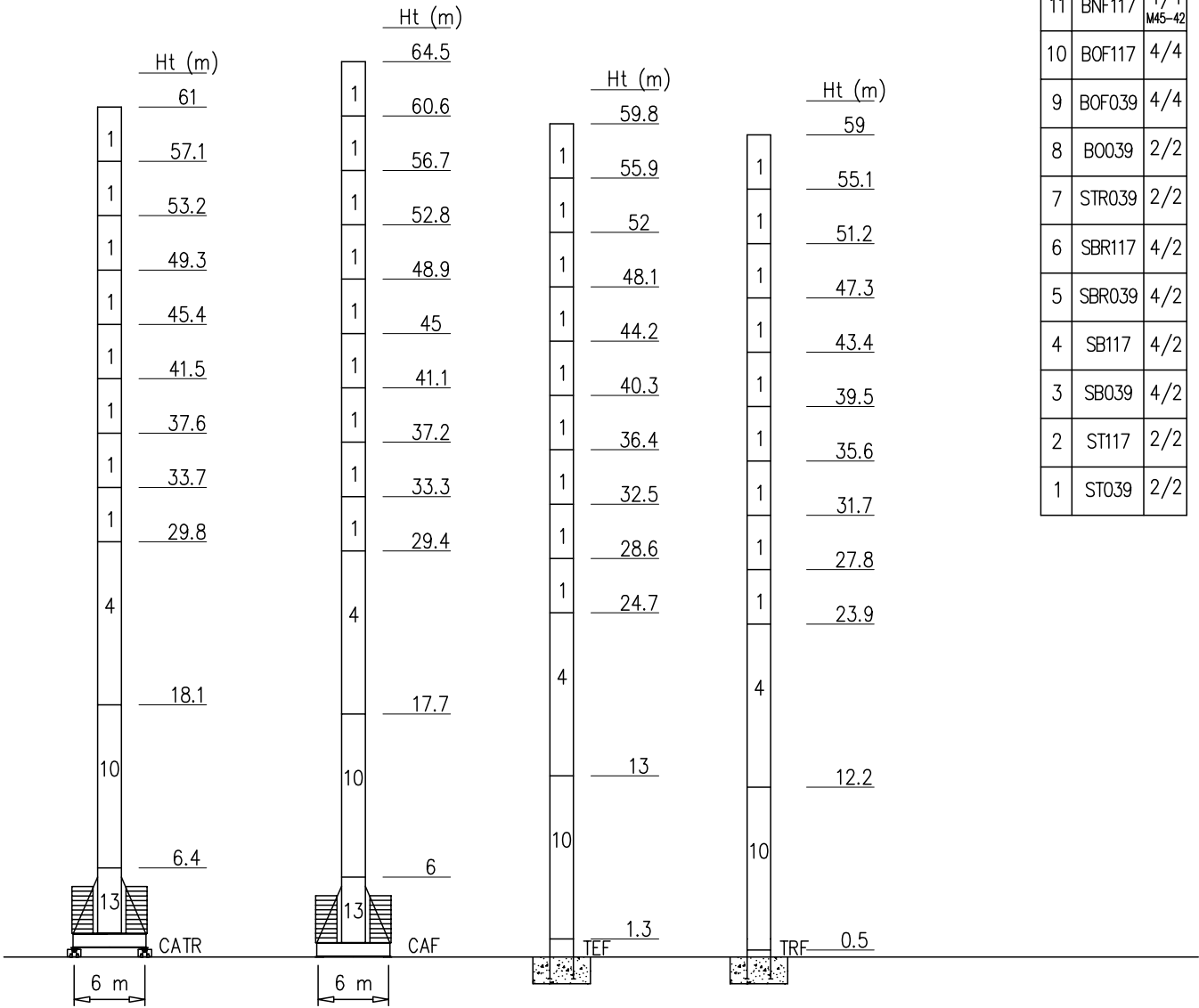

Peso zavorra – Ballast weight – Poids du lest – Ballastgewicht – Peso de lastre

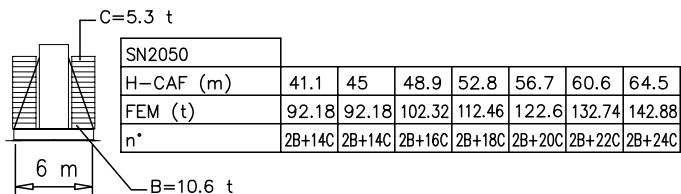
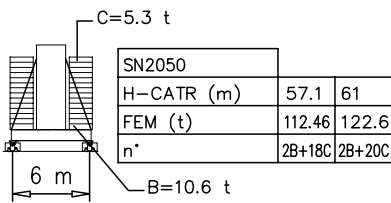

Torre/Reazioni – Masts/Reactions – Mat/Réactions – Maste/Eckdrücke – Mástil/Reacciones – Tramo/Reacções

SN2050 EN14439-C25

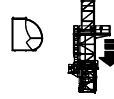
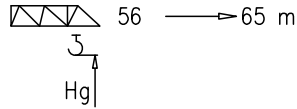

- Hg=Ht-1 m
- Hg=Ht-1.8 m

14	BCF052	2/4 M45
13	BAF052	2/4 M42
12	BPF117	4/4 M45-45
11	BNF117	4/4 M45-42
10	BOF117	4/4
9	BOF039	4/4
8	BO039	2/2
7	STR039	2/2
6	SBR117	4/2
5	SBR039	4/2
4	SB117	4/2
3	SB039	4/2
2	ST117	2/2
1	ST039	2/2

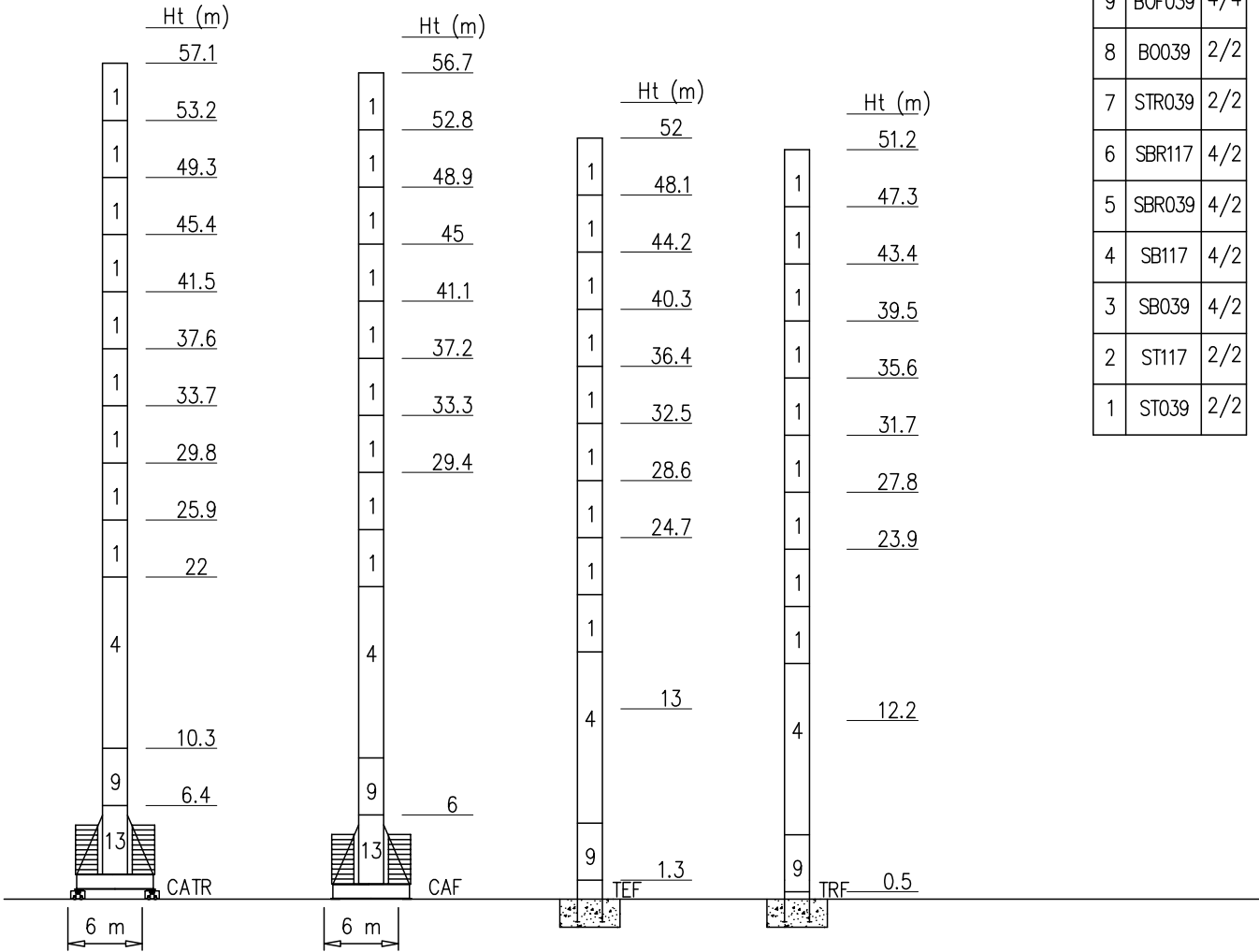

Peso zavorra – Ballast weight – Poids du lest – Ballastgewicht – Peso de lastre

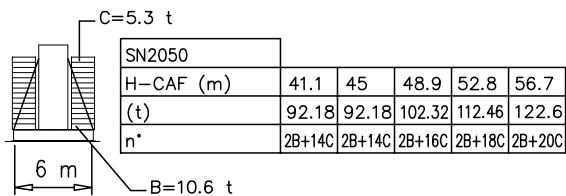
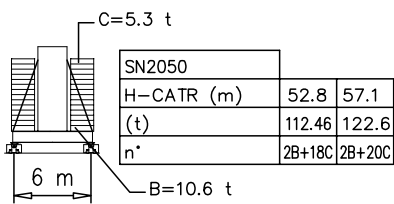

Torre/Reazioni – Masts/Reactions – Mat/Réactions – Maste/Eckdrücke – Măstil/Reacciones – Tramo/Reacções

SN2050 EN14439-D25

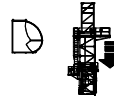
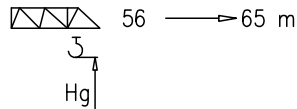

- Hg=Ht-1 m
- Hg=Ht-1.8 m

14	BCF052	2/4 M45
13	BAF052	2/4 M42
12	BPF117	4/4 M45-45
11	BNF117	4/4 M45-42
10	BOF117	4/4
9	BOF039	4/4
8	BO039	2/2
7	STR039	2/2
6	SBR117	4/2
5	SBR039	4/2
4	SB117	4/2
3	SB039	4/2
2	ST117	2/2
1	ST039	2/2

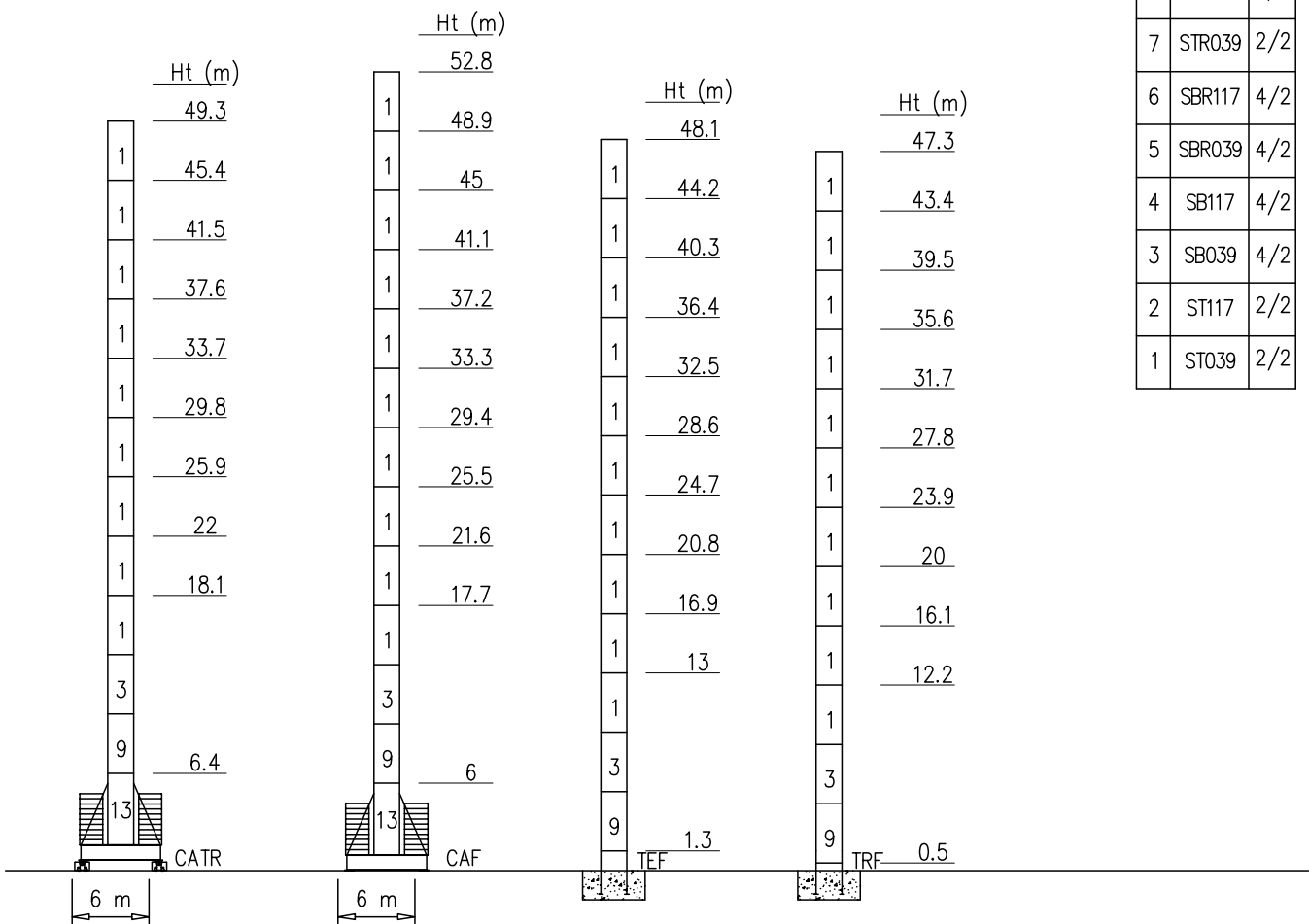

Peso zavorra – Ballast weight – Poids du lest – Ballastgewicht – Peso de lastre

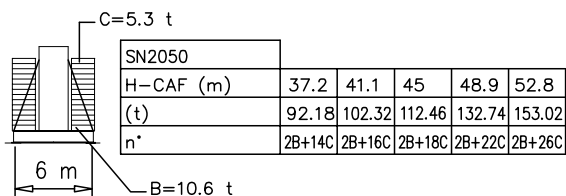
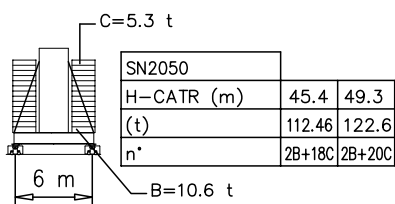



Curve di carico – Courbes de charges – Load diagrams – LastKurven – Curvas de cargas

Pmax 5000 kg

	25560 kg	65 m	3.5	22	26	30	34	36	38	40	42	44	46	48	50	52	54	56	58	60	63	65	m
			5000	5000	4050	3420	2950	2750	2570	2410	2260	2130	2010	1900	1800	1710	1620	1540	1470	1400	1200	1000	kg
	25560 kg	63 m	3.5	24.5	26	30	34	36	38	40	42	44	46	48	50	52	54	56	58	60	63	m	
			5000	5000	4050	3420	2950	2750	2570	2410	2260	2130	2010	1900	1800	1710	1620	1540	1470	1400	1300	kg	
	25560 kg	60 m	3.5		27.3	30	34	36	38	40	42	44	46	48	50	52	54	56	58	60	m		
			5000		5000	4050	3540	3210	2990	2800	2630	2480	2340	2210	2090	1990	1890	1800	1720	1700	kg		
	25560 kg	56 m	3.5		28.3	30	34	36	38	40	42	44	46	48	50	52	54	56	m				
			5000		5000	4830	4130	3840	3590	3300	3030	2870	2670	2540	2400	2300	2130	2000	kg				
	22720 kg	50 m	3.5		29.4	34	36	38	40	42	44	46	48	50	m								
			5000		5000	4470	4160	3890	3650	3430	3240	3060	2900	2500	kg								
	22720 kg	45 m	3.5		30.9	34	36	38	40	42	44	45	m										
			5000		5000	4470	4160	3890	3650	3430	3240	3100	kg										
	19880 kg	39 m	3.5		29.4	32	34	36	38	39	m												
			5000		5000	4830	4470	4160	3890	3500	kg												
	17040 kg	34 m	3.5		31.2	32	34	m															
			5000		5000	4830	4500	kg															

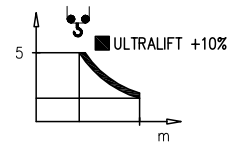





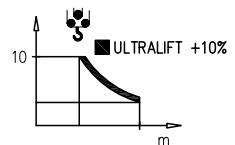



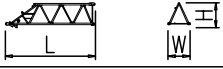
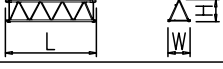

Pmax 10000/5000 kg



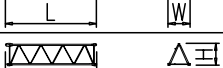
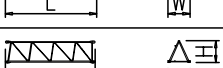



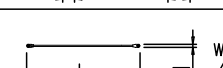
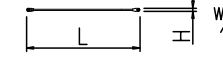
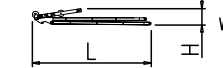
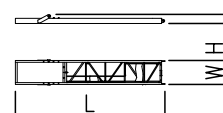
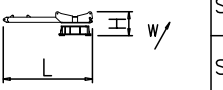
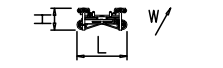
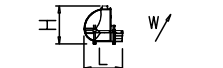



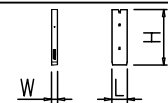

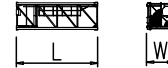
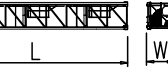
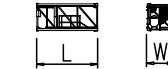

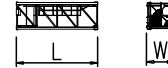
	25560 kg	65 m	3.5	12.4	20	22	26	30	34	36	38	40	42	44	46	48	50	52	54	56	58	60	63	65	m
			10000	10000	6360	5000	4050	3420	2950	2750	2570	2410	2260	2130	2010	1900	1800	1710	1620	1540	1470	1400	1200	1000	kg
	25560 kg	63 m	3.5	13.7	20	22	26	30	34	36	38	40	42	44	46	48	50	52	54	56	58	60	63	m	
			10000	10000	6360	5000	4050	3420	2950	2750	2570	2410	2260	2130	2010	1900	1800	1710	1620	1540	1470	1400	1300	kg	
	25560 kg	60 m	3.5	15.2	20	24	26	30	34	36	38	40	42	44	46	48	50	52	54	56	58	60	m		
			10000	10000	6870	5400	4870	4050	3540	3210	2990	2800	2630	2480	2340	2210	2090	1990	1890	1800	1720	1700	kg		
	25560 kg	56 m	3.5	15.8	20	22	26	30	34	36	38	40	42	44	46	48	50	52	54	56	m				
			10000	10000	8420	7180	5790	4830	4130	3840	3590	3300	3030	2870	2670	2540	2400	2300	2130	2000	kg				
	22720 kg	50 m	3.5	16.4	20	22	26	30	34	36	38	40	42	44	46	48	50	m							
			10000	10000	9500	7880	6260	5230	4470	4160	3890	3650	3430	3240	3060	2900	2500	kg							
	22720 kg	45 m	3.5	17.2	20	22	26	30	34	36	38	40	42	44	45	m									
			10000	10000	9500	7880	6260	5230	4470	4160	3890	3650	3430	3240	3100	kg									
	19880 kg	39 m	3.5	16.4	20	22	26	28	30	32	34	36	38	39	m										
			10000	10000	9500	7880	6260	5700	5230	4820	4470	4160	3890	3500	kg										
	17040 kg	34 m	3.5	17.4	20	22	26	28	30	32	34	m													
			10000	10000	9500	7880	6260	5700	5230	4820	4500	kg													

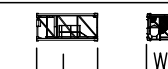
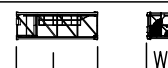

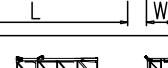
PESI E INGOMBRI – PACKING LIST – LISTE DE COLISAGE – GEWICHT UND ABMESSUNGEN

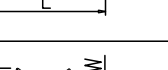
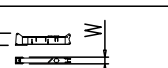
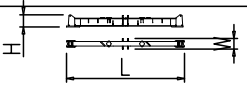
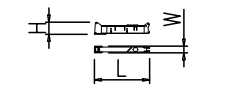
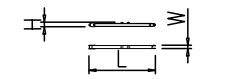
Denominazione Description	Disegno Draw	Pezzi Pieces	Dimensioni-Dimensions (mm)			Peso-Weight (kg)		
			L	W	H	Unit	Total	
Elemento di braccio Jib element Elèment de èche Elemento de flecha	n°1 	1	5760	1440	1600	950	–	
	n°2 	1	5820	1400	1470	750	–	
	n°3 	1	5860	1400	1470	810	–	
	n°4 	1	5860	1400	1470	730	–	
	n°5 	1	5860	1400	1470	740	–	
	n°6 	1	5850	1400	1470	700	–	
	n°7 	1	5820	1400	1470	680	–	
	n°8 	1	5820	1400	1470	740	–	
	n°9 	1	5850	1400	1450	520	–	
	n°10 	1	5740	1400	1450	410	–	
	n°11 	1	5770	1400	1450	330	–	
	n°12 	1	4350	1400	1450	320	–	
	Punta 	1	800	1400	1400	170	–	
Tirante completo Complete tie rod Tirant complète Tirante completo		12	6500	200	200	240	3540	
Cuspide Cusp Pointre Cùspide		1	8300	1500	1000	2700	–	
Contorbraccio completo Complete counterjib Contreflèche complète Contraflecha completa		1	9300	1650	600	2000	–	
Gruppo girevole Slewing group Table tournante Grupo giratorio		SK1700	1	5100	1810	1400	6000	–
		SN2050	1	5100	1810	1400	6300	–
Carrello Trolley Chariot Carretilla		1	1900	1620	1000	400	–	
Ballatoio con cabina Access balcony with cabin Porte cabine Balcòn corrido con cabina		1	2500	2150	2450	1000	–	

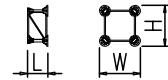
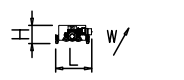
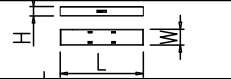
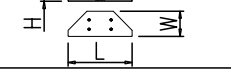
PESI E INGOMBRI – PACKING LIST – LISTE DE COLISAGE – GEWICHT UND ABMESSUNGEN

Denominazione Description	Disegno Draw	Pezzi Pieces	Dimensioni–Dimensions (mm)			Peso–Weight (kg)		
			L	W	H	Unit	Total	
Blocchi contrappeso Counterweight block Contre-poids Bloques de contrapeso	VX28 	9	1100	280	3700	2840	25600	
Elemento di torre Mast element Elément de mât Elemento de torre	ST039 	SK1700	–	3900	1785	1785	1750	–
	STR039 	SN2050	–	3900	2110	2110	2320	–
	ST052 	SK1700	–	5200	1785	1785	2250	–
	ST117 	SK1700	–	11700	1785	1785	4690	–
		SN2050	–	11700	2110	2110	5790	–
	SB039 	SK1700	–	3900	1785	1785	2100	–
	SB039 	SN2050	–	3900	2110	2110	2710	–
	SB052 	SK1700	–	5200	1785	1785	2600	–
	SB117 	SK1700	–	11700	1785	1785	2600	–
		SN2050	–	11700	2110	2110	3350	–
	SB117 SBR117 	SK1700	–	11700	1785	1785	4830	–
SB117 SBR117 	SN2050	–	11700	2110	2110	7000	–	
BOF039 B0039 	SK1700	–	3900	1785	1785	2450	–	
BOF039 B0039 	SN2050	–	3900	2110	2110	3370	–	
BOF052 	SK1700	–	5200	1785	1785	3390	–	
BOF052 	SN2050	–	5200	2110	2110	3880	–	
BOF117 BNF117 BPF117 	SK1700	–	11700	1785	1785	6920	–	
BOF117 BNF117 BPF117 	SN2050	–	11700	2110	2110	8180	–	
Elemento di base Base element Mat de base Elemento de base	BAF052 	SK1700	1	5200	2060	2060	3650	–
	BCF052 	SN2050	1	5200	2260	2260	4040	–
Carro di base Base carriage Chassis de base Cruceta de base		4.5x4.5	1	6670	500	1260	3180	3180
		5x5	1	7550	670	780	2300	2300
		6x6	1	8870	670	780	2500	2500
		4.5x4.5	2	3100	500	1260	1400	2800
		5x5	2	3530	420	780	1060	2120
		6x6	2	4320	420	780	1200	2400
Puntoni di base Rafter Jambes de force Cabrios de base		5x5	4	4250	240	300	280	1120
		6x6	4	4560	420	300	420	1680
Elemento a perdere Disposable frame Chassis a perdre Bastidor desechable		SK1700	1	1840	1910	1910	1430	–
		SN2050	1	2600	2260	2260	2030	–
Elemento recuperabile Recoverable frame Chassis récupérable Bastidor recuperable		SK1700	1	1300	2170	2170	1720	–
		SN2050	1	1300	2620	2620	1860	–
Bogie di traslazione Driven bogie Boggie motorisee Balancin de traslaciòn			4	1160	700	600	700	2800
Blocco zavorra di base Base ballast block Lest de base Bloque de lastre		4.5x4.5	–	4400	1200	290	3500	–
		5x5	2	5300	1000	600	7300	14600
	6x6	2	6400	1200	600	10600	21200	
		5x5	–	4100	1600	300	3500	–
6x6		–	4800	2000	300	5070	–	
Corsoio di montaggio Climbing cage Cage de montage Jaula de montaje		SK1700	1	8300	2600	2500	6000	–
		SN2050	1	8300	2900	2700	6700	–

GRU IN CAVEDIO – TELESOPAGE SUR DALLES – CLIMBING CRANE – KLETTERKRANE IM GEBAUDE

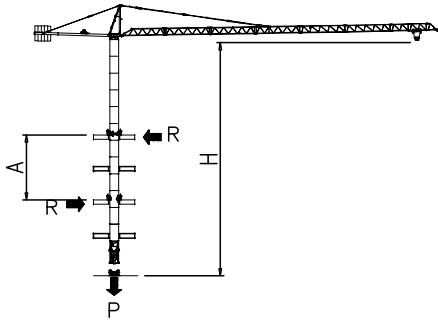

SK1700	H (m)	A (m)
	39	Min 9
Apertura passaggio gru Opening for crane passing 		Max 12

SN2050	H (m)	A (m)
	50.8	Min 9
Apertura passaggio gru Opening for crane passing 		Max 12

SOPRALZO IDRAULICO – TELESOPABLE – EXTERNAL CLIMBING – KLETTERKRANE

FEM

	SK1700
MAX C	32.5 m
B	19.5 m
A	46.8 m

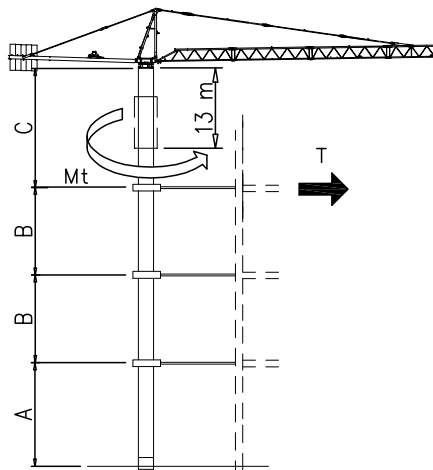

	SN2050
MAX C	36.4 m
B	23.4 m
A	46.8 m

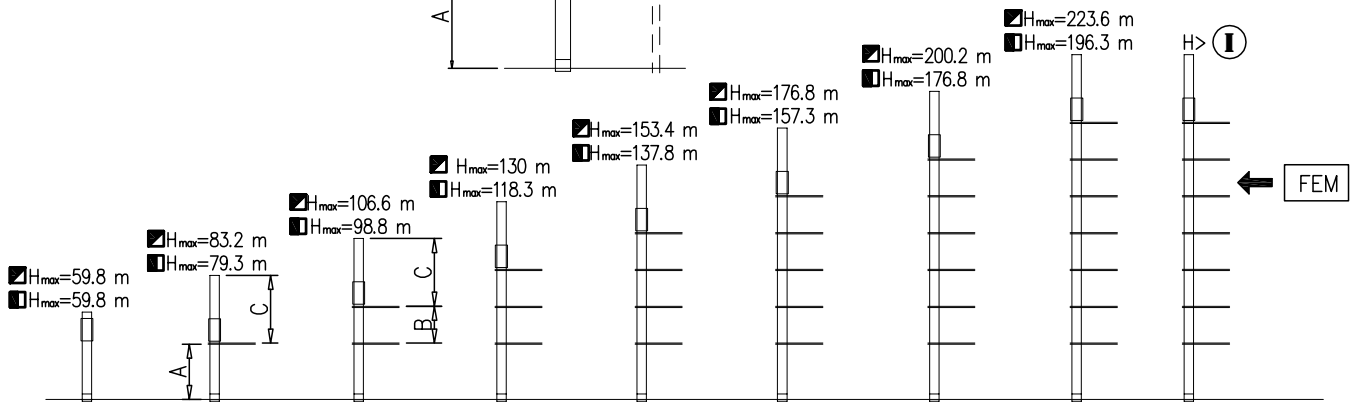

Montaggio – Montage – Erection – Montage – Montaje – Montagem

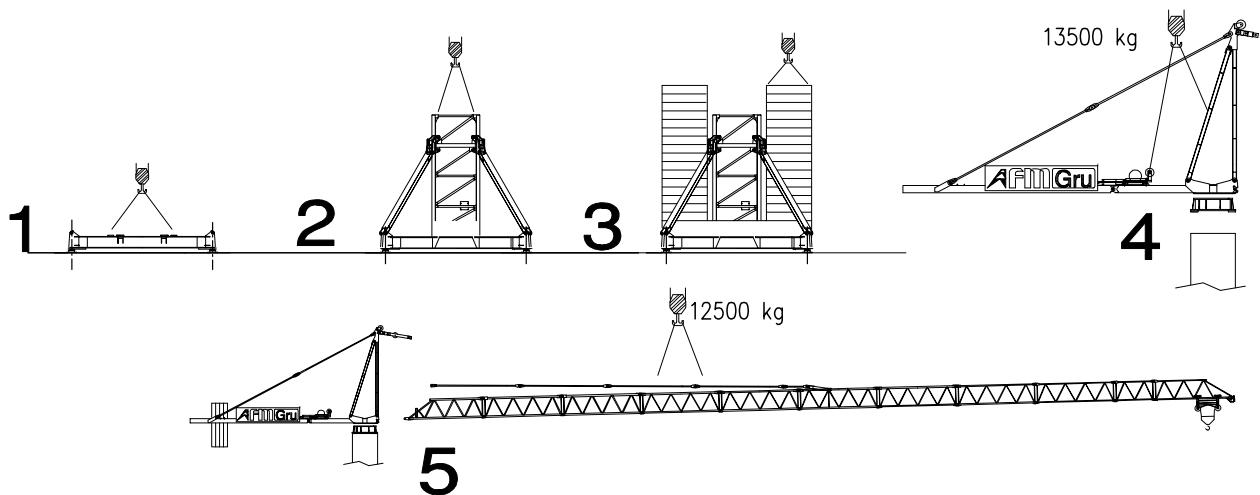

Meccanismi – Mechanisms – Mécanismes – Antriebe – Mecanismos

Sollevamento V45.60 Hoisting Levage Heben Elevaciòn Elevaçao							 m/min vs t	 m/min vs t	V45.60 33 kW 57 kVA  270 m 500 m (L)					
	m/min	3	14	30	45	60				72				
	t	5	5	5	3.5	2.4	1.4							
	m/min	1.5	7	15	22.5	30	36							
	t	10	10	10	7	4.8	2.8							
Sollevamento V75.105 Hoisting Levage Heben Elevaciòn Elevaçao							 m/min vs t	 m/min vs t	V75.105 55 kW 80 kVA  260 m 520 m (L)					
	m/min	4	20	40	63	78				105				
	t	5	5	5	3.7	2.8	1.7							
	m/min	2	10	20	31.5	39	52.5							
	t	10	10	10	7.4	5.6	3.4							
Sollevamento V100.130 Hoisting Levage Heben Elevaciòn Elevaçao													V100.130 75 kW 110 kVA  360 m 750 m (L)	
	m/min	5	28	54	86	115	130	3	14	27	43	57		65
	t	5	5	5	4	2.8	1.4	10	10	10	8	5.6		2.8
	 m/min vs t						 m/min vs t							
Sollevamento V100.170 Hoisting Levage Heben Elevaciòn Elevaçao													V100.170 75 kW 110 kVA  388 m 776 m (L)	
	m/min	7	35	67	107	147	170	3.5	17.5	33.5	53.5	73.5		85
	t	5	5	5	2.5	1.6	0.6	10	10	10	5	3.2		1.2
	 m/min vs t						 m/min vs t							

Meccanismi – Mechanisms – Mécanismes – Antriebe – Mecanismos

Sollevamento V170.220 Hoisting Levage Heben Elevaciòn Elevaçao													V170.220 125 kW 150 kVA  388 776 m (L)	
	m/min	7	40	90	135	170	220	3.5	20	45	67.5	85		110
	t	5	5	5	4	3.1	1.5	10	10	10	8	6.2		3

Carrello Trolleying Distribution Katzfahren Distribuciòn Distribuiçao			0 → 85	m/min	3.6 kW	Potenza elettrica necessaria Puissance électrique nécessaire Necessary electric power Anschlusswert – Potencia
Rotazione Slewing Orientation Schwenken Orientaciòn Rotaçao			0 → 0,9	giri/min tr/min rp/min	4.4 kW @ 1200rpm n° 2 x 2.2 kW	
Traslazione Travelling Translation Kranfahren Traslaciòn Translaçao			0 → 20	m/min	7.5 kW	

Rete elettrica – Réseau – Mains supply – Netzstrom – Red – Rede electrica	400V – 50 Hz
---	--------------

Rete elettrica – Réseau – Mains supply – Netzstrom – Red – Rede electrica	400V – 50 Hz
---	--------------

FEM 1.001 – A4 EN 14439 – C25 – D25	
--	--